

# HANOVER<sup>®</sup>

## Hanover Outdoor Furniture



### **IMPORTANT**

If you have any problems with this product (missing or damaged parts, assembly issues, etc.),

**PLEASE DO NOT RETURN TO THE RETAILER/STORE**

from where you purchased the product.

Please call our Toll-Free Customer Service Hotline at: **1-800-416-3511**

Between 9:00 AM and 5:00 PM Eastern Time, Monday through Friday

Or visit our website at: **[www.hanover-products.com](http://www.hanover-products.com)**

To expedite any future warranty claims, please retain the Instruction Sheet, Warranty Card and receipt for future use.

For additional on-line support on assembly, troubleshooting and care & maintenance of your outdoor furniture, please visit our website at: **[www.hanover-products.com](http://www.hanover-products.com)**.

**IMPORTANT!! PLEASE READ ENTIRE INSTRUCTION SHEET BEFORE ASSEMBLY!!  
TO EXPEDITE WARRANTY CLAIMS PLEASE KEEP INSTRUCTION SHEET, WARRANTY CARD AND COPY OF RECEIPT**

**Step 1:** Carefully remove glass and set aside until Step 5. Lay glass flat--do not stand glass on edge. Remove all protective materials and set parts on a flat, non-abrasive surface. Identify parts packed in carton against the parts list. If you are missing any parts or are unsure how to proceed with assembly, call our Customer Service Center at 1-800-416-3511. **Do not attempt assembly if any parts are missing or damaged.**

**Step 2:** Place the table rim (without glass) upside down on a flat, non-abrasive surface. Attach the table leg to the rim by using a 1/4"x25 mm bolt and a washer as shown in *Figure 1*. Guide the bolt through the hole in the table leg, into the pre-drilled hole in the table rim. **Do not tighten completely.** Some adjustments may be necessary to ensure proper alignment of the table legs. Repeat for the other three table legs.

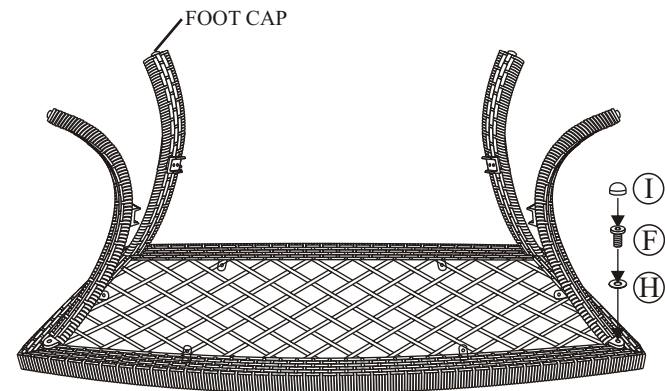

*Figure 1*

**Step 3:** Attach the leg connector bracket to the legs by using the 1/4"x35 mm bolts as shown in *Figure 2*. Add a washer to each bolt. Guide these bolts through the holes in the leg connector bracket, into the fixed nuts already in place in the legs. **Do not over tighten.**

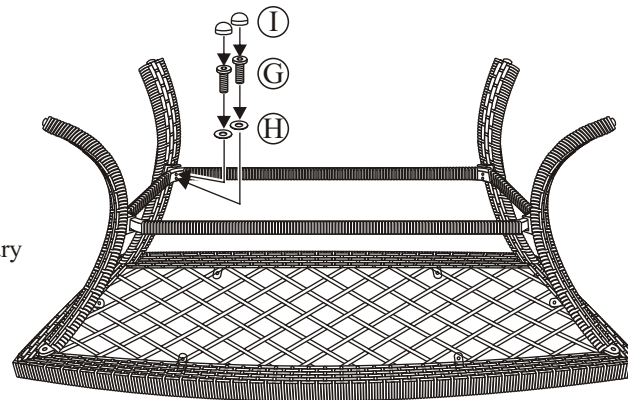

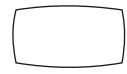









*Figure 2*

**Step 4:** After making any necessary adjustments to the alignment of the table legs and the leg connector bracket, use hex bolt driver to tighten all bolts. **Note:** Each bolt must be tightened a few revolutions at a time. In order to apply equal pressure to all bolt joints, we recommend working in a cross corner (X fashion). Repeat until all bolts are tight. **Do not over tighten.** Over tightening may strip bolts or damage the welds or frame. Cover all bolts with covers.

**Step 5:** With the help of another person, turn the table in the upright position. Note the clear bumpers spaced evenly throughout the inside of the rim. Carefully place glass inside the rim, resting on the clear bumpers. Your table is now ready for use. If you have any questions, please call our Customer Service Center at 1-800-416-3511.

**IMPORTANT NOTE: Damage to welds or frames resulting from over tightened bolts or improper assembly is not covered under our warranty. Please read all instructions carefully before assembly. If you have any questions regarding your assembly, call our Customer Service Center at 1-800-416-3511.**

*\* NOTE: PARTS SHOWN ON PARTS LIST ARE NOT TO SCALE*

	<u>PARTS LIST</u>	<u>DESCRIPTION</u>	<u>ORDER PART #</u>	<u>QTY</u>
A		GLASS TOP		1
B		TABLE RIM	ST1601	1
C		LEG CONNECTOR BRACKET	ST1602	1
D		TABLE LEG	ST1603	4
E		HEX BOLT DRIVER	HW0006	1
F		1/4" X 25 MM BOLT	HW0037	4
G		1/4" X 35 MM BOLT	HW0142	8
H		Ø6.5 X 1.0 MM WASHER	HW0004	12
I		BOLT COVER	HW0105	12
		BUMPER FACTORY ASSEMBLY	G0002	
		FOOT CAP FACTORY ASSEMBLY	FC0069	

**BKS04310**

**IMPORTANT. PLEASE READ ENTIRE INSTRUCTION SHEET BEFORE ASSEMBLY.**

**TO EXPEDITE ANY FUTURE WARRANTY CLAIMS, PLEASE KEEP INSTRUCTION SHEET, WARRANTY CARD AND RECEIPT**

- Step 1:** Identify all parts packed in the carton against the parts list. Remove all protective materials. If any parts are missing or damaged, call our Customer Service Center at 1-800-416-3511. **Do not attempt assembly any parts are missing or damaged.**
- Step 2:** Attach the seat frame to the back frame by using four 5/16"x40 mm bolts and washer as shown in *Figure 1*. Guide these bolts through the holes in the seat frame, into the fixed nuts already in place in the back frame. **Do not over tighten.**
- Step 3:** Attach love seat arm by inserting two 5/16"x25 mm bolts with washers through the holes in front seat portion of the love seat frame and into the holes in the love seat arm shown in *Figure 2*. Attach back of love seat arm by inserting two 5/16"x40 mm bolts with washers through holes in the back portion of love seat frame and into the holes in the rear portion of the love seat arm as shown in *Figure 2*. **Hand tighten only.** Repeat for the opposite side.
- Step 4:** Tighten all bolts using the hex bolt driver provided. Tighten each bolt a few revolutions at a time, alternating between bolt connections until all bolts are tight. **Do not over tighten. Over tightening may strip bolts or damage the welds or frame.** Cover all bolts with bolt covers provided.
- Step 5:** Your love seat is now ready for use. If you have any questions, please call our Customer Service Center at 1-800-416-3511.

**IMPORTANT NOTE:** Damage to welds or frames resulting from over tightened bolts or improper assembly is not covered under our warranty. Please read all instructions carefully before assembly. If you have any questions regarding your assembly, call our Customer Service Center at 1-800-416-3511.

\* NOTE: PARTS SHOWN ON PARTS LIST ARE NOT TO SCALE

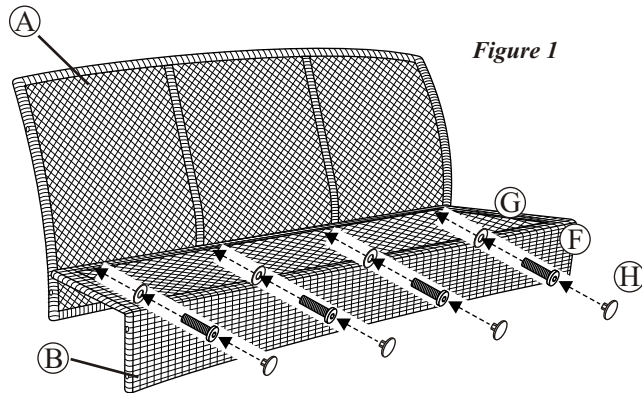

Figure 1

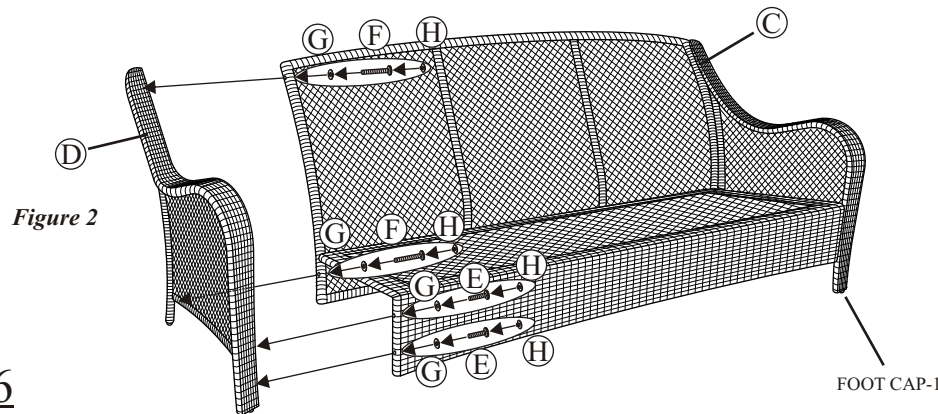

Figure 2

**BGC08006**

	<u>PARTS LIST</u>	<u>DESCRIPTION</u>	<u>ORDER PART #</u>	<u>QTY</u>
A		BACK FRAME	SK0939	1
B		SEAT FRAME	SK0940	1
C		LEFT ARM	SK0941	1
D		RIGHT ARM	SK0942	1
E		5/16" X 25 MM BOLT	HW0186	4
F		5/16" X 40 MM BOLT	HW0275	8
G		Ø8.5 X 1.5 MM WASHER	HW0005	12
H		BOLT COVER	HW0022	12
I		HEX BOLT DRIVER	HW0006	1
		FOOT CAP-1 FACTORY ASSEMBLY	FC0030	
		FOOT CAP-2 FACTORY ASSEMBLY	FC0308	